

Caratteristiche

- Nuovo elegante, stile contemporaneo. Una combinazione perfetta per le macchine del ghiaccio modulari e le altre macchine Icematic.
- Paletta ghiaccio incorporata, e trattamento Antibatterico Agion per una migliore sanitizzazione.
- Isolamento poliuretano ad alta densità.
- Deposito interno in polietilene lineare, per la massima compatibilità con gli alimenti e raggiata per agevolare la pulizia, inoltre è resistente ai graffi causati dal prelievo del ghiaccio.
- Parte frontale e perimetrale del deposito in acciaio, e sportello accesso ghiaccio resistente agli urti in plastica ottenuta con tecnologia rotocast.
- Regolazione piedini da 135mm a 185mm.
- Deposito con ruote, disponibile su richiesta.
- Guarnizione sportello ghiaccio totalmente removibile e che isola riducendo lo scioglimento del ghiaccio, facilmente asportabile e pulibile.
- Scarico del deposito con tubo ruotabile di 360°, di facile connessione con ogni scarico a pavimento.



Features

- New sleek, contemporary styling. A perfect match to Modular ice machine and other Icematic Ice Machines.
- Scoop incorporates, antimicrobial Agion for better sanitation.
- Polyurethane Insulation, high density.
- Polyethylene bin interior, is sanitary and easy to clean, and resist scratches and scuffs from ice scoops.
- Stainless steel bin exterior, robust door frame will resist operational abuse (rotocast technology).
- Adjustment of feet from 135 mm to 185 mm.
- Bin Caster available on request.
- Fully removable door gasket seals door opening to reduce ice melt, easily disassembled for manual cleaning.
- Storage bin base drain tube conveniently rotates at 360° radius to allow ease-of-connection with any floor water drain position.

Mod.	Volume interno Internal Volume	Max Capacità ghiaccio Max Ice Capacity		Dimensioni (LPH) Dimension (WDH)	Peso netto Net Weight	Peso lordo Gross Weight	Dati spedizione Shipping data
D105	0,264 m ³	129 Kg*	101 Kg**	568 x 848 x 1048 mm	36 Kg	50 Kg	620 x 885 x 1050 mm 50 kg ca.
D155	0,340 m ³	168 Kg*	132 Kg**	568 x 880 x 1270 mm	48 Kg	62 Kg	620 x 940 x 1310 mm 62 kg ca.
D205	0,368 m ³	181 Kg*	141 Kg**	768 x 848 x 1048 mm	43 Kg	56 Kg	822 x 885 x 1050 mm 56 kg ca.
D255	0,496 m ³	243 Kg*	191 Kg**	770 x 880 x 1270 mm	55 Kg	70 Kg	830 x 950 x 1310 mm 70 kg ca.
D305	0,513 m ³	252 Kg*	197 Kg**	1081 x 824 x 968 mm	48 Kg	63 Kg	1140 x 910 x 960 mm 63 kg ca.
D405	0,830 m ³	406 Kg*	319 Kg**	1235 x 873 x 1270 mm	73 Kg	97 Kg	1300 x 940 x 1310 mm 97 kg ca.
D505	0,970 m ³	478 Kg*	375 Kg**	1331 x 880 x 1270 mm	77 Kg	100 Kg	1395 x 940 x 1310 mm 100 kg ca.

* : Capacità "Application" calcolata sul 90% del volume totale in metri cubi moltiplicato per 545 kg/m³ / Application capacity is calculated on 90% of total volume in the cubic feet x 34 lb/ft³ - 545 kg/m³

** : Capacità "AHRI" calcolata sull'80% del volume totale in metri cubi moltiplicato per 481 kg/m³ / AHRI capacity is calculated on 80% of total volume in the cubic feet x 30 lb/ft³ - 481 kg/m³

D105

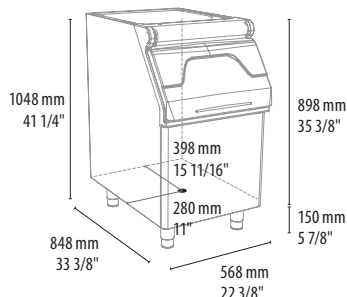

D155

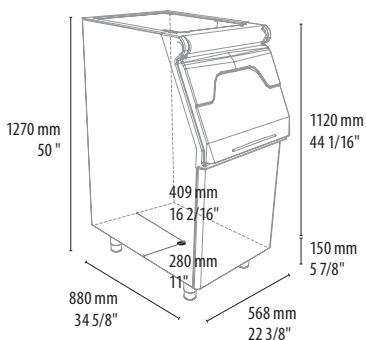

D205

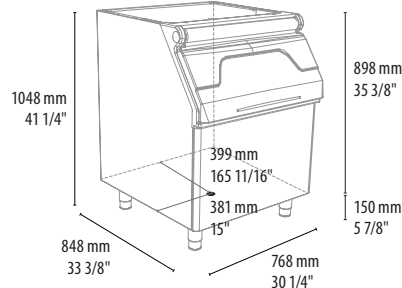

D255

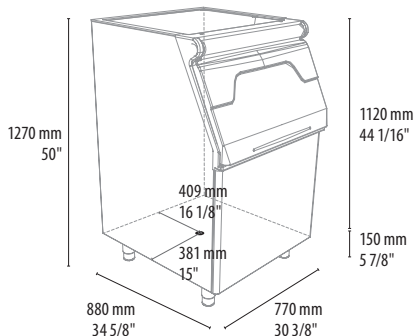

D305

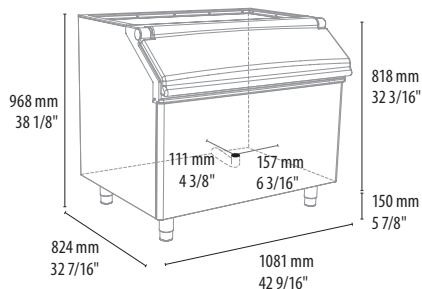

D405

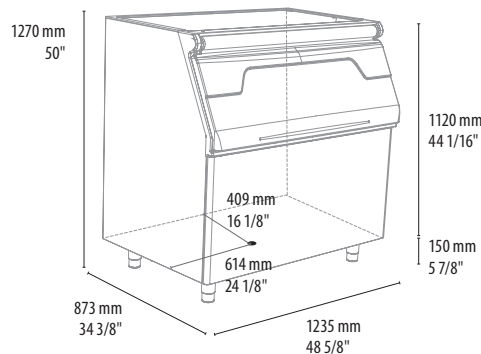

D505

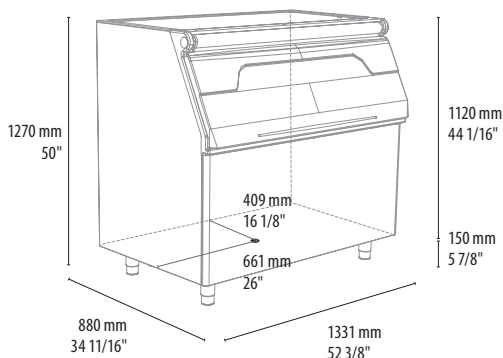

Mod.	Produttori Ghiaccio Ice Machines
D105	M132 / M192 / M195 ECO F120 / F200 NU270 / NU470
D155	M 132 / M 192 / M 195 ECO F 120 / F 200 NU 270 / NU 470
D205	M 132 + KM 205-255 / M 192 + KM 205-255 / M 205 / M 205 ECO / M302 / M402 F 120 + KF205-255 / F 200 + KF205-255 / SF 300 + KF205-255 / SF 500 + KF205-255 NU 270 + KF205-255 NU470 + KF205-255
D255	M132 + KM205-255 / M192 + KM205-255 / M202 / M205 ECO M302 / M402 M502 F120 + KF205-255 / F200 + KF205-255 / SF300 + KF205-255 / SF500 + KF205-255 NU270 + KF205-255 / NU470 + KF205-255
D305	M202 + KM305 / M205 ECO + KM305 / M302 + KM305 M402 + KM305 / M502 + KM305 F120 + KF305 / F200 + KF305 / SF300 + KF305 / SF500 + KF305 NU270 + KF305 / NU470 + KF305
D405	M 202 + KFM 405 / M302 + KFM 405 / M402 + KFM 405 / M502 + KFM 405 F 200 + KFM 405 SF 300 + KFM 405 SF 500 + KFM 405 NU 270 + KFM 405 NU470 + KFM 405
D505	M 202 + KFM 505 / M 302 + KFM 505 / M 402 + KFM 505 / M 502 + KFM 505 F 200 + KFM 505 / SF 300 + KFM 505 / SF 500 + KFM 505 NU 270 + KFM 505 / NU 470 + KFM 505

Piedi regolabili 130-185 mm / Adjustable legs 5 2/16"-7 4/16"
Scarico deposito diametro 20 mm / Discharge bin water diameter 12 7/8"