













Dati Tecnici - Specifications

											
	cond	comp. W	ABS. W	Fuse	Kwh/100Kg	l / h	kg	Lbs	kg	Lbs	Ton CO2 equiv.
SF500 A		5030	2000	16	10.2	18	95	207	104	227	3,84
SF500 W		5030	2000	16	8.7	185	95	207	104	227	2,75

24h Produzione Ghiaccio - Ice Production (kg/lbs)

Raffreddamento ad aria - Air Cooled Unit

Temp. aria Air Temp.	Temp. acqua / Water Temp.			
	32°	21°	15°	10°
°C	32°	21°	15°	10°
°F	90°	70°	60°	50°
10°	440	520	560	600
50°	970	1146	1234	1323
21°	420	500	540	580
70°	926	1102	1190	1278
32°	380	440	470	500
90°	838	970	1036	1102
38°	330	370	390	410
100°	727	816	860	904

Raffreddamento ad acqua - Water Cooled Unit

Temp. aria Air Temp.	Temp. acqua / Water Temp.			
	32°	21°	15°	10°
°C	32°	21°	15°	10°
°F	90°	70°	60°	50°
10°	480	540	570	600
50°	1058	1190	1256	1323
21°	470	530	560	590
70°	1036	1168	1234	1300
32°	460	520	550	580
90°	1014	1146	1212	1278
38°	450	513	540	570
100°	992	1131	1190	1256



PANNELLO DI CONTROLLO - CONTROL PANEL



DEPOSITO - BIN

D205 - D255 - D305 - D405-D505

UD500-UD700-DR140 - DR320

DIMENSIONI - DIMENSIONS

LxPxH(mm): 538 x 663 x 790

WxDxH(in): 21 3/16" x 26 2/16" x 31 2/16"

DATI SPEDIZIONE / SHIPPING DATA

LxPxH(mm): 600 x 750 x 930

WxDxH(in): 23"10/16 x 29"8/16 x 36"10/16

TIPO GHIACCIO - ICE TYPE

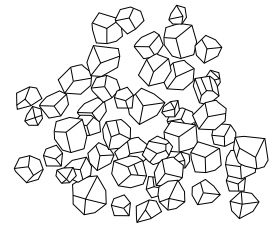

PERCENTUALE ACQUA RESIDUA 25%
ICE CONTAINS 25% RESIDUAL WATER

CONDIZIONI USO - OPERATING REQUIREMENTS



220-240V / 50Hz / 1



R452a GWP=3922

MIN

MAX

10°C (50°F)

40°C (104°F)

5°C (41°F)

35°C (95°F)

- 10 %

+ 10 %

1 BAR (14 PSI)

5 BAR (70 PSI)

Calore espulso - Rejected Heat
Volume aria - Air Volume

6447 W
1500 m³/h

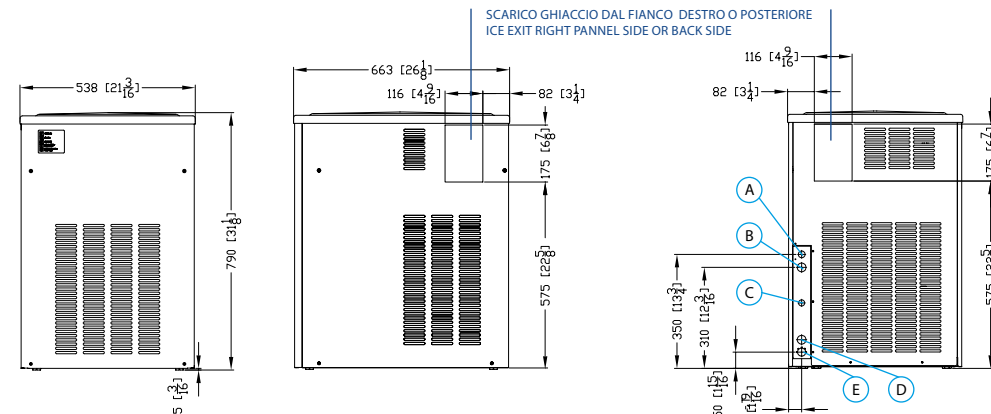

- A** Alimentazione elettrica
Electrical cable supply
- B** Attacco entrata acqua 3/4" gas
Water inlet connection 3/4" gas
- C** Entrata acqua - raffr. acqua 3/4" gas
Water inlet - cooled unit 3/4" gas
- D** Uscita acqua condensazione ad acqua Ø 20 mm
Water outlet connection-Water condensation Ø 20 mm
- E** Attacco scarico acqua
Water drain ø 20 mm

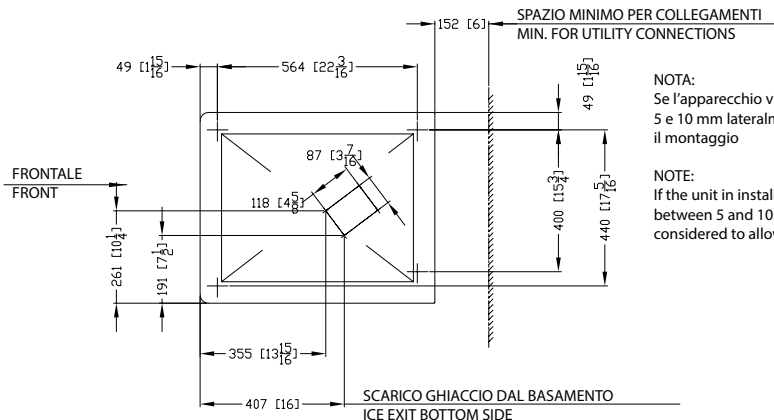

NOTA:
Se l'apparecchio viene incassato, lasciare lo spazio tra 5 e 10 mm lateralmente alla macchina per facilitare il montaggio

NOTE:
If the unit is installed as a built-in / undercounter, between 5 and 10 mm in each side must be considered to allow for ease of installation



Condensatore remoto Optional
Remote condenser Optional