













Dati Tecnici - Specifications

											
	cond	comp. W	ABS. W	Fuse	Kwh/100Kg	l / h	kg	Lbs	kg	Lbs	Ton CO2 equiv.
NU270 A		2650	1200	16	11.6	9	78	172	87	192	2,94



Produzione Ghiaccio - Ice Production

Raffreddamento ad aria - Air Cooled Unit

Temp. aria Air Temp.	Temp. acqua / Water Temp.			
	32°	21°	15°	10°
°C	32°	21°	15°	10°
°F	90°	70°	60°	50°
10°	230	250	260	270
50°	507	551	573	595
21°	225	245	255	265
70°	496	540	562	584
32°	195	215	225	235
90°	430	474	496	518
38°	170	190	200	210
100°	375	419	441	463



PANNELLO DI CONTROLLO - CONTROL PANEL



DEPOSITO - SLOPE BIN

D205-D255 (KF205-255) D305 (KF305)

DIMENSIONI - DIMENSIONS

LxPxH(mm): 538 x 663 x 650
WxDxH(in): 21 3/16" x 26 2/16" x 25 10/16"

DATI SPEDIZIONE / SHIPPING DATA

LxPxH(mm): 600 x 750 x 840
WxDxH(in): 23 10/16 x 29 8/16 x 33 1/16"

TIPO GHIACCIO - ICE TYPE



NU270S SMALL

Ø 11 x 13 mm - 1 gr
humidity 8%

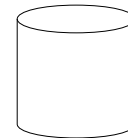

NU270 MEDIUM

Ø 17 x 18 mm - 5 gr
humidity 8%

CONDIZIONI USO-OPERATING REQUIREMENTS



220-240V / 50Hz / 1



R404a GWP=3922

MIN

10°C (50°F)

5°C (41°F)

- 10 %

1 BAR (14 PSI)

MAX

40°C (104°F)

35°C (95°F)

+ 10 %

5 BAR (70 PSI)

Calore espulso - Rejected Heat
Volume aria - Air Volume

1630 W/h
1000 m³/h

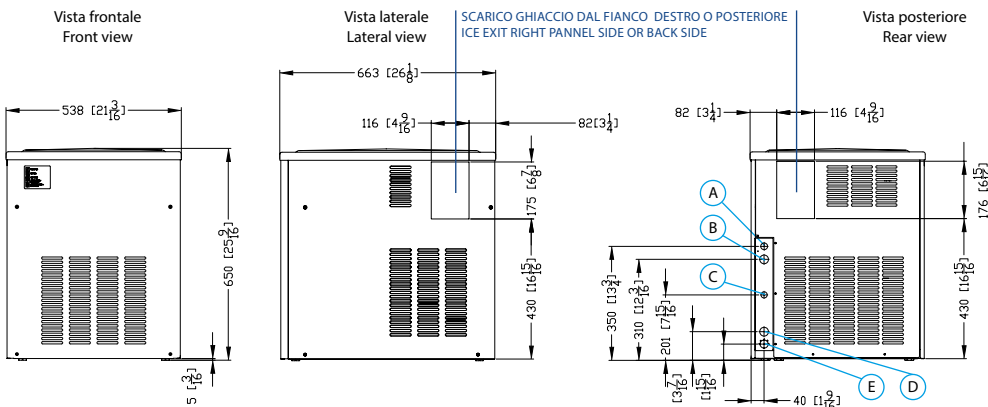

- A** Alimentazione elettrica
Electrical cable supply
- B** Attacco entrata acqua 3/4" gas
Water inlet connection 3/4" gas
- C** Entrata Acqua - raffr. acqua 3/4" gas
Water inlet - water cooled unit 3/4" gas
- D** Scarico acqua - raffr. acqua 3/4" gas
Water outlet - water cooled unit 3/4" gas
- E** Scarico acqua ø 20 mm
Water outlet ø 20 mm

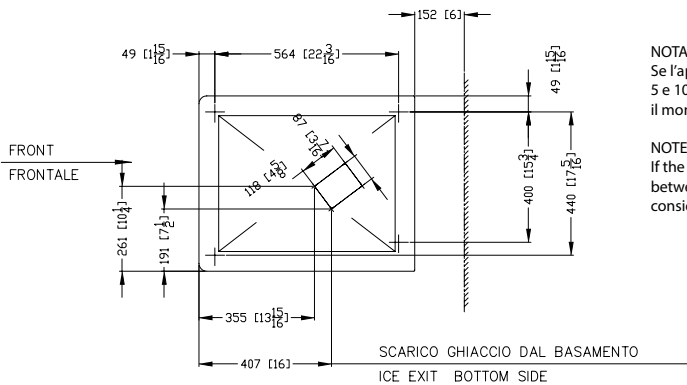

NOTA:
Se l'apparecchio viene incassato, lasciare lo spazio tra 5 e 10 mm lateralmente alla macchina per facilitare il montaggio

NOTE:
If the unit is installed as a built-in / undercounter, between 5 and 10 mm in each side must be considered to allow for ease of installation