













Dati Tecnici - Specifications

	 cond	 comp. W	 ABS. W	 Fuse	 Kwh/100Kg	 I / h	 kg	 Lbs	 kg	 Lbs
NU 470 A		5000	2250	16	13.0	16.8	94	207	103	227
NU 470 W		5000	2050	16	9.0	277.0	94	207	103	227



Produzione Ghiaccio - Ice Production

Raffreddamento ad aria - Air Cooled Unit

Temp. Aria Air Temp.	Temp. Acqua / Water Temp.				
		32°	21°	15°	
°C					
°F					
10°					570
50°					1254
21°					530
70°					1166
32°		390			
90°		585			
38°					
100°					

Raffreddamento ad acqua - Water Cooled Unit

Temp. Aria Air Temp.	Temp. Acqua / Water Temp.				
		32°	21°	15°	
°C					
°F					
10°					640
50°					1408
21°					605
70°					1331
32°		530			
90°		1166			
38°					
100°					

Vista frontale
Front view

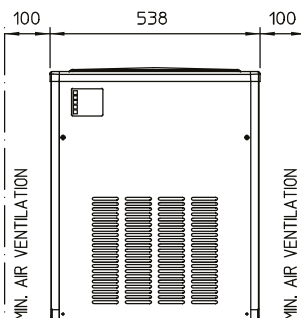

Vista laterale
Lateral view

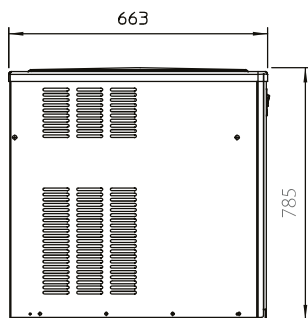

Vista superiore
Top view

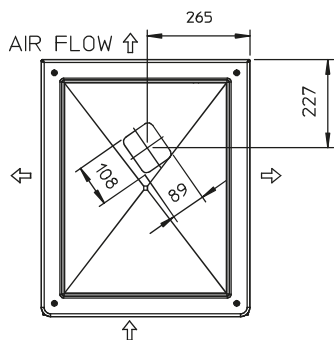

UNITÀ DI MISURAmm

- Ø 21 mm SCARICO ACQUA
- 3/4" GAS - ENTRATA ACQUA
- 3/4" GAS - SCARICO ACQUA SOLO RAFFREDD. ACQUA
- 3/4" GAS - ENTRATA ACQUA SOLO RAFFREDD. ACQUA
- CAVO DI ALIMENTAZIONE

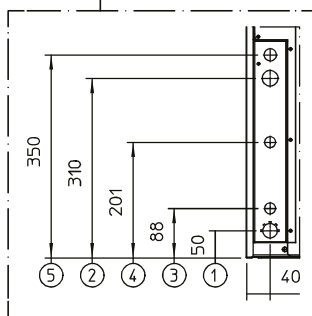

PANNELLO DI CONTROLLO - CONTROL PANEL





DEPOSITO - SLOPE BIN

D305-D405-D505 - UD SERIES

DIMENSIONI - DIMENSIONS

LxPxH (mm)

	538 x 663 x 794
	21" 3/16 x 26" 2/16 x 31" 4/16
	610 x 760 x 960
	24" x 29" 15/16 x 37" 3/16

TIPO GHIACCIO - ICE TYPE







CONDIZIONI USO-OPERATING REQUIREMENTS



400/50/3



R452A GWP = 2141

MIN		MAX
10°C (50°F)		40°C (104°F)
5°C (41°F)		35°C (95°F)
- 10 %		+ 10 %
1 Bar (14 psi)		5 Bar (70 psi)