













Dati Tecnici - Specifications

											
	cond	comp. W	ABS. W	Fuse	Kwh/100Kg	l / h	kg	Lbs	kg	Lbs	Ton CO2 equiv.
NU470 A		5030	2000	16	12	15	94	207	103	227	3,84



Produzione Ghiaccio - Ice Production

Raffreddamento ad aria - Air Cooled Unit

Temp. aria Air Temp.	Temp. acqua / Water Temp.			
	32°	21°	15°	10°
°C	32°	21°	15°	10°
°F	90°	70°	60°	50°
10°	410	440	455	470
50°	904	970	1003	1036
21°	380	410	425	440
70°	838	904	937	970
32°	330	360	375	390
90°	728	794	827	860
38°	300	330	345	360
100°	661	728	760	794

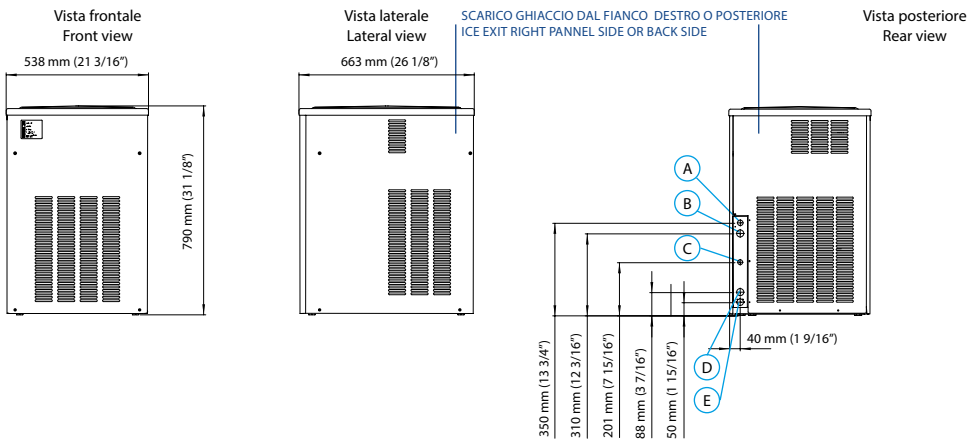

- A** Alimentazione elettrica
Electrical cable supply
- B** Attacco entrata acqua 3/4" gas
Water inlet connection 3/4" gas
- C** Entrata Acqua - raffr. acqua 3/4" gas
Water inlet - water cooled unit 3/4" gas
- D** Scarico acqua - raffr. acqua 3/4" gas
Water outlet - water cooled unit 3/4" gas
- E** Scarico acqua ø 20 mm
Water outlet ø 20 mm

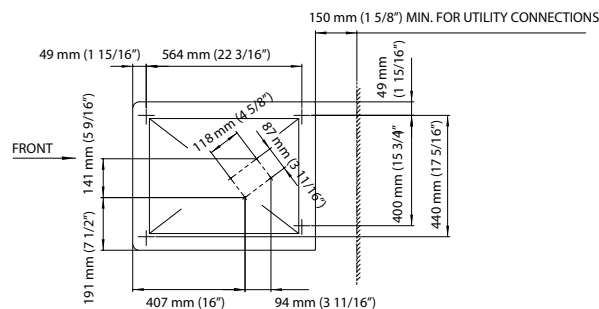

NOTA:
Se l'apparecchio viene incassato, lasciare lo spazio tra 5 e 10 mm lateralmente alla macchina per facilitare il montaggio

NOTE:
If the unit is installed as a built-in / undercounter, between 5 and 10 mm in each side must be considered to allow for ease of installation



PANNELLO DI CONTROLLO - CONTROL PANEL



DEPOSITO - SLOPE BIN

D205-D255(KF205-255) - D305(KF305)

DIMENSIONI - DIMENSIONS

LxPxH(mm): 538 x 663 x 790
WxDxH(in): 21 3/16" x 26 2/16" x 31 2/16"

DATI SPEDIZIONE / SHIPPING DATA

LxPxH(mm): 600 x 750 x 970
WxDxH(in): 23"10/16 x 29"8/16 x 38"3/16

TIPO GHIACCIO - ICE TYPE

NU470S SMALL
Ø 11 x 13 mm - 1 gr
humidity 8%

NU470 MEDIUM
Ø 17 x 18 mm - 5 gr
humidity 8%





CONDIZIONI USO-OPERATING REQUIREMENTS



220-240V / 50Hz / 1



R404a GWP=3922

MIN		MAX
10°C (50°F)		40°C (104°F)
5°C (41°F)		35°C (95°F)
- 10 %		+ 10 %
1 BAR (14 PSI)		5 BAR (70 PSI)

Calore espulso - Rejected Heat **2906 W/h**
Volume aria - Air Volume **1500 m³/h**

NU470 230V/1N/50Hz Self contain - Ice Flaker