













Dati Tecnici - Specifications

											
	cond	comp. W	ABS. W	Fuse	Kwh/100Kg	l / h	kg	Lbs	kg	Lbs	Ton CO2 equiv.
SF300 A		2650	1200	16	10.8	11	78	172	87	192	2,94
SF300 W		2650	1200	16	9	115	78	172	87	192	2,35

24h Produzione Ghiaccio - Ice Production (kg/lbs)

Raffreddamento ad aria - Air Cooled Unit

Temp. aria Air Temp.	Temp. acqua / Water Temp.			
	32°	21°	15°	10°
°C	32°	21°	15°	10°
°F	90°	70°	60°	50°
10°	260	290	305	320
50°	573	639	672	705
21°	255	285	300	315
70°	562	628	661	694
32°	210	240	255	270
90°	463	529	562	595
38°	190	220	235	250
100°	419	485	518	551

Raffreddamento ad acqua - Water Cooled Unit

Temp. aria Air Temp.	Temp. acqua / Water Temp.			
	32°	21°	15°	10°
°C	32°	21°	15°	10°
°F	90°	70°	60°	50°
10°	270	300	315	330
50°	595	661	694	728
21°	265	295	310	325
70°	584	650	683	716
32°	260	290	305	320
90°	573	639	672	705
38°	250	280	295	310
100°	551	617	650	683

SCARICO GHIACCIO DAL FIANCO DESTRO
ICE EXIT RIGHT PANNELL SIDE

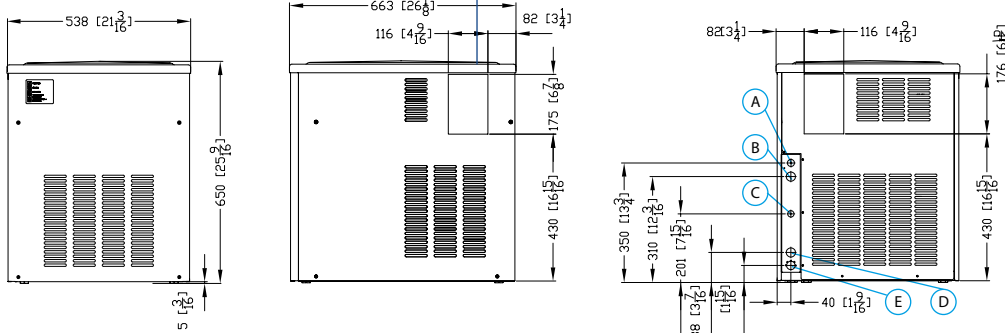

- A** Alimentazione elettrica
Electrical cable supply
- B** Attacco entrata acqua 3/4" gas
Water inlet connection 3/4" gas
- C** Entrata acqua - raffr. acqua 3/4" gas
Water inlet - cooled unit 3/4" gas
- D** Uscita acqua condensazione ad acqua Ø 20 mm
Water outlet connection-Water condensation Ø 20 mm
- E** Attacco scarico acqua
Water drain ø 20 mm

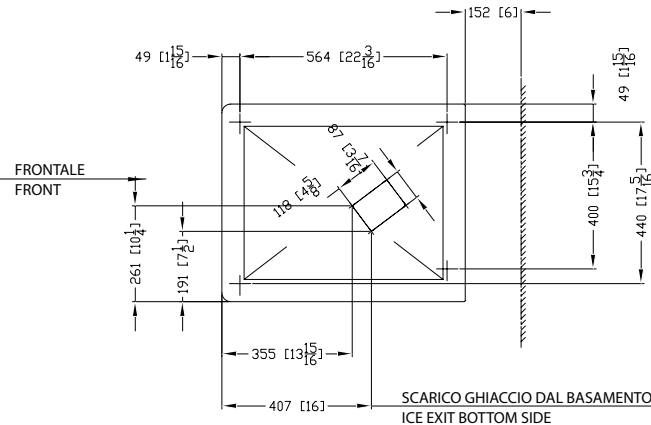

NOTA:
Se l'apparecchio viene incassato, lasciare lo spazio tra 5 e 10 mm lateralmente alla macchina per facilitare il montaggio

NOTA:
If the unit is installed as a built-in / undercounter, between 5 and 10 mm in each side must be considered to allow for ease of installation



PANNELLO DI CONTROLLO - CONTROL PANEL



DEPOSITO - BIN

D105 - D155 - D205 - D255 - D305
D405 - DR140 - DR320

DIMENSIONI - DIMENSIONS

LxPxH(mm): 538 x 663 x 650
WxDxH(in): 21 3/16" x 26 2/16" x 25 10/16"

DATI SPEDIZIONE / SHIPPING DATA

LxPxH(mm): 600 x 750 x 800
WxDxH(in): 23"10/16 x 29"8/16 x 31"8/16

TIPO GHIACCIO - ICE TYPE

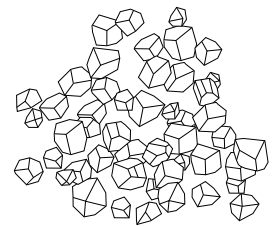

PERCENTUALE ACQUA RESIDUA 25%
ICE CONTAINS 25% RESIDUAL WATER

CONDIZIONI USO-OPERATING REQUIREMENTS



220-240V / 50Hz / 1



R452a GWP=3922

MIN

MAX

10°C (50°F)



40°C (104°F)

5°C (41°F)



35°C (95°F)

- 10 %



+ 10 %

1 BAR (14 PSI)



5 BAR (70 PSI)

Calore espulso - Rejected Heat
Volume aria - Air Volume

3452 W
1000 m³/h